



Rush Creek

CREATIONS



Life Time Friendly Customer Service

844-627-4480

ProductSupport@rushcreekcreations.com



All Rush Creek Creations products have a 90-day from date of purchase warranty. This warrants the retail purchaser for any Rush Creek Creations product purchased to be free from any defect in materials and construction for 90 days from the date of purchase.

Manufacturer Defects: Defective parts will be replaced at no cost to you. Please send an e-mail to productsupport@rushcreekcreations.com including photos of the defective part(s), the name of your retailer, and your shipping address and we will send replacements.

If you love our products please let us know! Write a review on your retailer's site, on our site, on Facebook, tag us on Instagram, or drop us a note at ProductSupport@rushcreekcreations.com.

Not Satisfied? – Let us know! We are here for you, REAL people in Milwaukee, WI. We hunt and fish and use our products and we stand by them. Reach out to us or email us, we want to help.



Service à la clientèle pratique et toujours disponible

844-627-4480

ProductSupport@rushcreekcreations.com



Tous les produits Rush Creek Creations sont couverts par une garantie de 90 jours à partir de la date d'achat. Celle-ci garantit à l'acheteur au détail que les produits Rush Creek Creations sont exempts de tout défaut de matériaux et de construction pendant 90 jours à partir de la date d'achat.

Défauts dus au fabricant : Les pièces défectueuses seront remplacées gratuitement. Veuillez envoyer un courriel à ProductSupport@rushcreekcreations.com en incluant des photos de la ou des pièces défectueuses et le nom de votre revendeur, et nous vous enverrons les pièces de remplacement.

Si vous aimez nos produits, faites-le nous savoir! Écrivez un commentaire sur le site du détaillant, sur notre site, sur Facebook, signalez-nous sur Instagram ou laissez-nous une note à l'adresse ProductSupport@rushcreekcreations.com

Vous n'êtes pas satisfait? – Faites-le-nous savoir! Nous sommes là pour vous, et nous sommes de VRAIES personnes, à Milwaukee (Wisconsin). Nous chassons et pêchons, nous utilisons nos produits et nous les accompagnons de notre assistance. Joignez-nous ou envoyez-nous un courriel. Nous voulons vous aider.



Servicio de atención al cliente amigable de por vida

844-627-4480

ProductSupport@rushcreekcreations.com



Todos los productos de Rush Creek Creations tienen una garantía de 90 días a partir de la fecha de compra. Esto garantiza que el comprador minorista de productos de Rush Creek Creations adquiera productos sin defectos de materiales y construcción y que esté cubierto durante 90 días a partir de la fecha de compra.

Defectos de fábrica: Las piezas defectuosas se reemplazarán sin costo alguno. Envíe un correo electrónico a ProductSupport@rushcreekcreations.com con fotos de las piezas defectuosas, el nombre de la tienda minorista y la dirección de envío para que podamos mandarle los repuestos.

Si le gustan nuestros productos, ¡cuéntenoslo! Escriba una reseña en el sitio del vendedor minorista, en nuestro sitio o en Facebook, etiquétenos en Instagram o envíenos unas líneas a ProductSupport@rushcreekcreations.com.

¿No está conforme? ¡Infórmenoslo! Estamos aquí para ayudarlo: personas REALES en Milwaukee, Wisconsin. Nosotros mismos usamos nuestros productos de caza y pesca, y los aprobamos. Si necesita ayuda, llámenos o envíenos un correo electrónico.

14-Rod Storage Rack

support de canne à pêche
estante de la barra de pesca

Item # / Article n° / Artículo N.º
38-3009

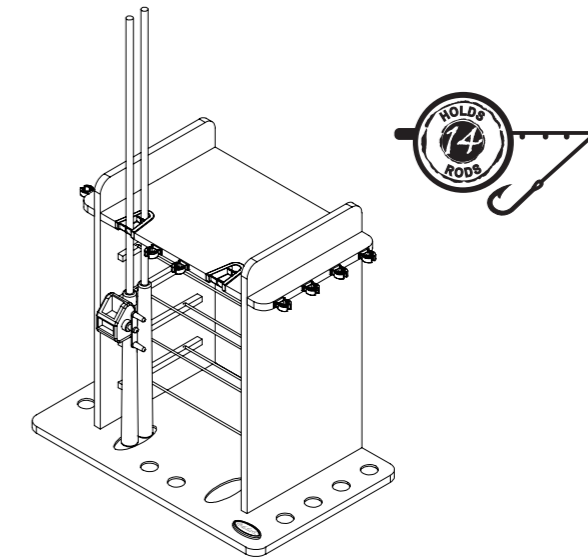

Please keep this instruction manual for future reference

Veuillez conserver ce manuel d'instructions pour consultation future
Conserve este manual de instrucciones para consultarlo en el futuro

TECHNICAL SUPPORT OR REPLACEMENT PARTS
ASSISTANCE TECHNIQUE OU PIÈCES DE REMPLACEMENT
ASISTENCIA TÉCNICA O REPUESTOS

CONTACT INFO COORDONÉES INFORMACIÓN DE CONTACTO

Hours / Heures / Horario

Monday - Friday / Du lundi au vendredi / De lunes a viernes

(9:00am to 5:00pm CST) / (de 9 h 00 à 17 h 00, HNC) / (de 9:00 a 17:00, CST)

Email us at: / Envoyez-nous un courriel à l'adresse: / Correo electrónico: productsupport@rushcreekcreations.com

Visit us at: / Consultez notre site Web: / Sitio web: www.rushcreekcreations.com

Call us at: / Appelez-nous au: / Teléfono: **1-844-627-4480**





For all replacement part needs: Please visit us at www.rushcreekcreations.com, click on CONTACT US and complete all required fields (all fields with asterisks must be completed before submitting)

You will receive a response within 48 hours.

Pour tous les besoins de pièces de remplacement: Veuillez consulter notre site Web www.rushcreekcreations.com, cliquez sur COMMUNIQUEZ AVEC NOUS et remplissez tous les champs obligatoires (tous les champs avec astérisques doivent être remplis avant l'envoi). Vous recevrez une réponse dans les 48 heures.

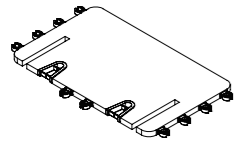
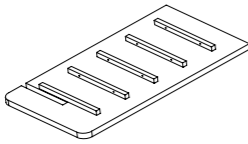
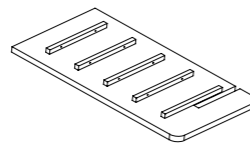
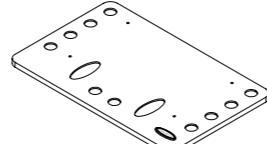
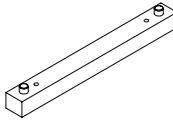
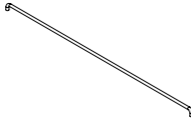
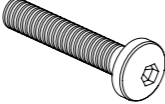
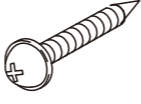
Si necesita repuestos: visítenos en www.rushcreekcreations.com, haga clic en "CONTACT US" y complete todos los campos obligatorios (debe completar todos los campos con asteriscos antes de enviar el formulario). Recibirá una respuesta en menos de 48 horas.

Parts List / Liste des pieces / Lista de partes

1  x1	2  x1	3  x1	4  x1
5  x2	6  x8	7  x4	8  x4
9  x4	10  x4	11  x1	

